

# Accessories

## Wire Guards

**Wire Guard 1**  
Catalog Number: WG1-L

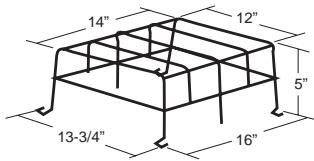

**Wire Guard 6**  
Catalog Number: WG6-L

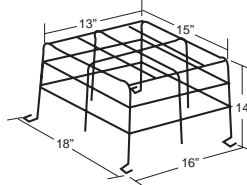

**Wire Guard 12**  
Catalog Number: WG12-L

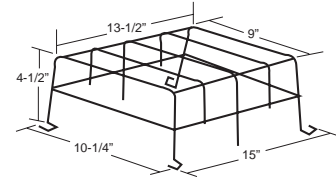

**Wire Guard 2**  
Catalog Number: WG2-L

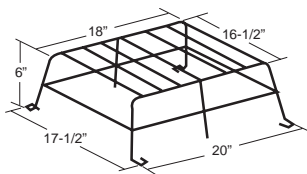

**Wire Guard 8**  
Catalog Number: WG8-L

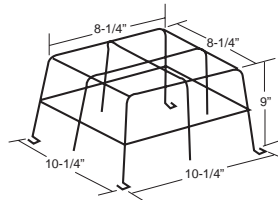

**Wire Guard 13**  
Catalog Number: WG13-L

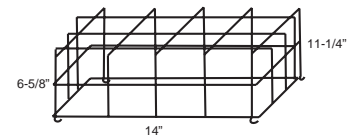

**Wire Guard 3**  
Catalog Number: WG3-L

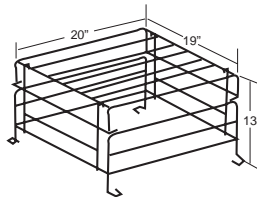

**Wire Guard 9**  
Catalog Number: WG9-L

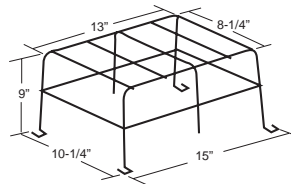

**Wire Guard 14**  
Catalog Number: WG14-L

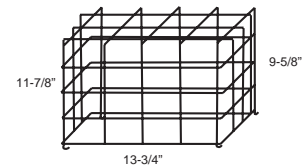

**Wire Guard 4**  
Catalog Number: WG4-L

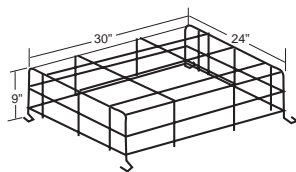

**Wire Guard 10**  
Catalog Number: WG10-L

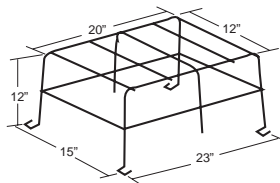

**Wire Guard 15**  
Catalog Number: WG15-L

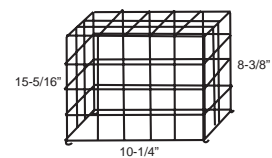

**Wire Guard 5**  
Catalog Number: WG5-L

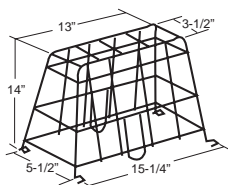

**Wire Guard 11**  
Catalog Number: WG11-L

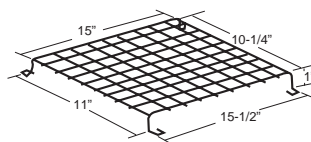

**Wire Guard 17**  
Catalog Number: WG17-L

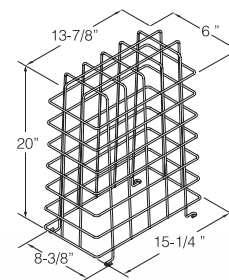

Dimensions are approximate and subject to change.

# Accessories



- 14 gauge steel
- Corrosion resistant undercoat
- Oven baked finish
- 1/2" retaining lip on three sides
- Keyhole slots for easy mounting

Model	Dimensions (inches)						
	A	B	C	D	E	F	G
MP-PQB (Mist)	17	7 <sup>3</sup> / <sub>4</sub>	12 <sup>1</sup> / <sub>4</sub>	16	3/4	5/16	5/8
MP-A (Gray)	17	7 <sup>3</sup> / <sub>4</sub>	12 <sup>1</sup> / <sub>4</sub>	16	3/4	5/16	5/8
MP-PQA (Mist)	16 <sup>3</sup> / <sub>8</sub>	5 <sup>3</sup> / <sub>4</sub>	10 <sup>1</sup> / <sub>4</sub>	12 <sup>1</sup> / <sub>2</sub>	7/8	3/16	7/16
MP12	27 <sup>1</sup> / <sub>2</sub>	7 <sup>3</sup> / <sub>4</sub>	12 <sup>1</sup> / <sub>4</sub>	16	1 <sup>5</sup> / <sub>8</sub>	5/32	5/16

Dimensions are approximate and subject to change.

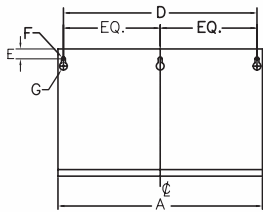

MP-PQB + MP-A

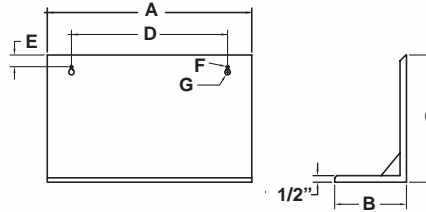

MP-PQA

## Mounting Platforms

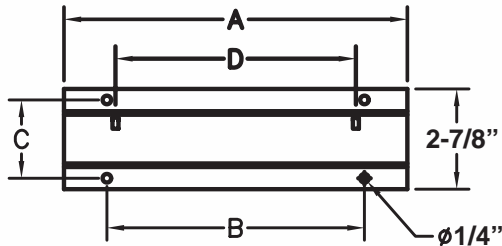

- 16 gauge steel
- Corrosion resistant undercoat
- Oven baked finish
- Supplied with rubber stand-offs for unit and machine screws to secure unit to bracket

Model	Dimensions (inches)			
	A	B	C	D
MB-A	10	7 <sup>3</sup> / <sub>4</sub>	2 <sup>3</sup> / <sub>16</sub>	7
MB-B	14 <sup>1</sup> / <sub>4</sub>	11 <sup>3</sup> / <sub>4</sub>	2 <sup>3</sup> / <sub>16</sub>	12 <sup>5</sup> / <sub>8</sub>

Dimensions are approximate and subject to change.

## Mounting Brackets

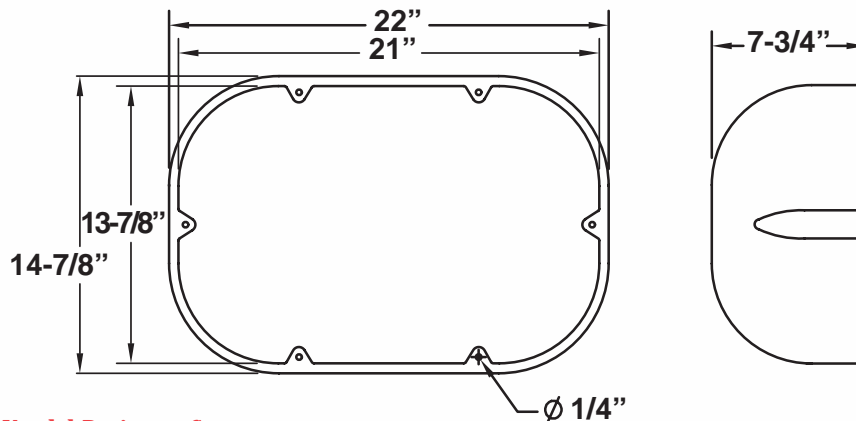

### Vandal Resistant Cover

Application: MG Series

Catalog Number: CPS or CPS-4X (NEMA-4X)

Dimensions are approximate and subject to change.

## Vandal Resistant Covers