

Cluster™ LED LCA-2LEDR Unit & ELF652D Remote Head Series

Offered in a family concept, with exit combination units and remote



Housing

- UV stabilized thermoplastic body
- Fully adjustable Cluster™ LED glare-free heads
- Choice of white or black housing

Mounting

- Ceiling or wall mount
- Universal J-box mounting

Lamp Type

- White LED 3.6V-3.6W, with life expectancy 50,000+ hours, 70 lumens per head

Electronics

- Pulse plus charger
- Low voltage disconnect
- Automatic brownout protection
- Battery lock-out
- Fused output circuit
- Optional: Improved Diagnostics
- 120/277 60Hz

Photometric performance

Spacing center-to-center (feet)	
7 feet mounting height	15 feet mounting height
15'	4'

Sealed Maintenance-Free Battery

3.6V Nickel-Cadmium battery

Approvals

- UL 924 listed
- Damp location 50°F to 104°F (10°C to 40°C)
- UL 94, 5VA flame rated
- BC- California Energy Commission Title 20

Warranty (subject to proper installation and maintenance)

Three-year full warranty

Detailed warranty terms located on [page 182](#) or online at: www.lightalarms.com

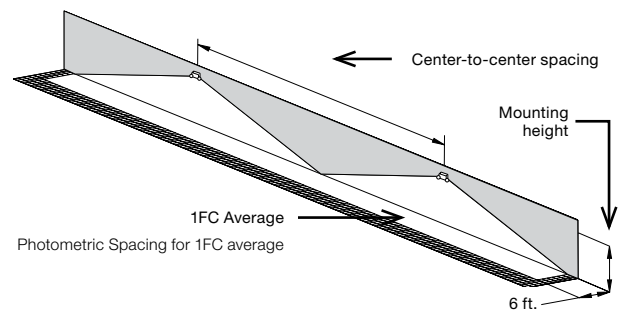

Dimensions (Dimensions are approximate and subject to change)

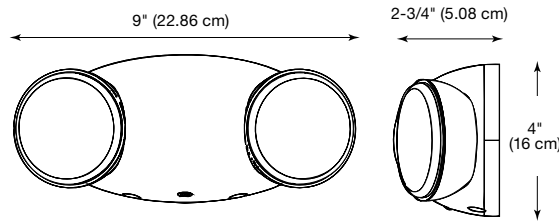

Power consumption chart

	AC Specs	DC Specs
Series	120VAC, 60Hz	277VAC, 60Hz
LCA-2LEDR	0.191/0.92	0.129/1.62

Ordering format - Battery unit

Series	Lamp	Capacity	Color
LCA	-2LED= Cluster LED head style	Blank= No Remote R= Remote capacity ¹ RID= Remote capacity with Improved Diagnostics ¹	Blank= Mist-white B= Black
Example: LCA-2LEDR			

¹ Remote Capacity can ONLY be used to power the Cluster™ LED ELF652D Remote Head or the extend the battery units emergency run time beyond the standard 90 minutes.

ELF652D/LED Series
Indoor remote head



ELF652D/LED-WP Series
Outdoor remote head



The Cluster™ LED ELF652D/LED Remote head can ONLY be powered from the UQLXN-2LED combo or LCA 2LED battery units of the same family. Used for internal or external applications, the indoor remote head draws 3.6V-3.6W and Weather-Proof head draws 3.6V-3.8W

Dimensions

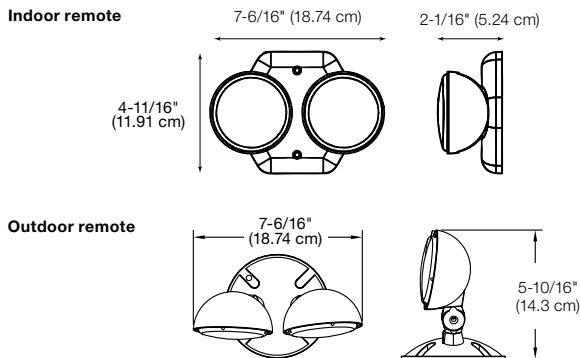

Photometric performance

Spacing center-to-center (feet)	
7 feet mounting height	15 feet mounting height
15'	4'

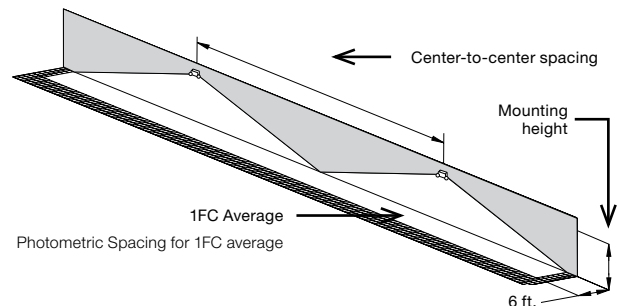

Ordering format

Series	Number of heads	Lamp	Option
ELF652	D= Double head	/LED= Cluster™ LED head style	Blank= Indoor use only -WP= Weather-proof

Example: ELF652D/LED