

# Triad

## Triad LED Replacement Lamps LED Retrofit Kit



- Convert high consumption incandescent and fluorescent lamps to energy efficient LED lamps.
- Reduce energy consumption by up to 90%
- Improve visibility and reliability
- Reduce maintenance costs

### FEATURES

- Quick and easy to install
- Available with wide range of lamp bases for quick lamp to lamp replacement
- Available in ultra high-brightness Red LED's (Red LED's only)
- 120Vac only

### POWER CONSUMPTION CHART

Model	AC Specs	
LRB	120Vac	0.90W
LRB-F	120Vac	1.6W



### DIMENSIONS

Dimensions are approximate and subject to change.

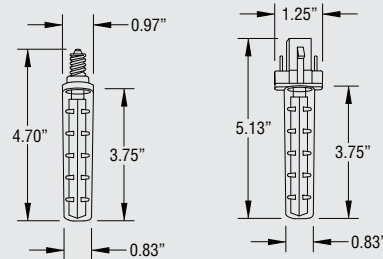

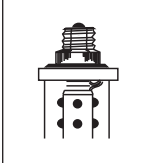
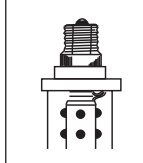
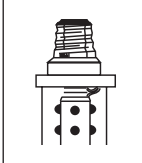
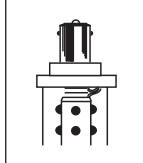
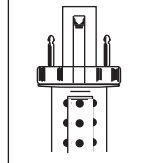
<b>LRB-C</b> Candelabra Base 	<b>LRB-I</b> Intermediate Screw Base 	<b>LRB-M</b> Medium Screw Base 	<b>LRB-B</b> D.C. Bayonet Base 	<b>LRB-F</b> PL 5, 7 or 9 Watt Base 
--	--	--	--	---

### ORDERING FORMAT

LRB	-C
<b>Model</b>	<b>Base</b>
	-C= Candelabra
	-I= Intermediate
	-M= Medium
	-B= Bayonet
	-F= Compact Fluorescent



# LED Retrofit Kit

### DIMENSIONS

Dimensions are approximate and subject to change.

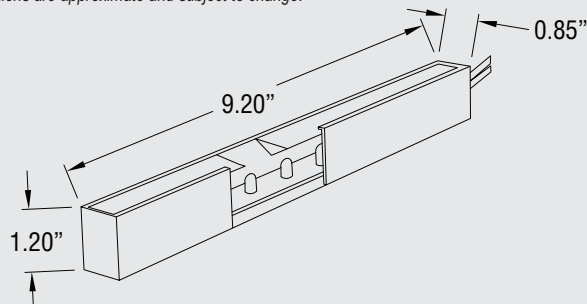

### FEATURES

- Easiest to install in its class
- Compact size makes it ideal for virtually all exit signs
- Can be retrofitted directly on fluorescent ballast
- Long-Life, energy-efficient red (only) LED technology
- Available with AC adaptor for various type of lamp sockets
- 120Vac only

### POWER CONSUMPTION CHART

Model	AC Specs	
LEC-RX	120Vac	1.70W

### ORDERING FORMAT

LEC-RX	-C
<b>Model</b>	<b>Base</b>
	-C= Candelabra
	-I= Intermediate
	-M= Medium
	-B= Bayonet
	-F= Compact Fluorescent